

# INSTRUKCJA MONTAŻU

FITTING-UP INSTRUCTION / AUFBAUANLEITUNG

MONTÁŽNÍ NÁVOD / MONTÁŽNY NÁVOD

Producent:  
**Restol sp. z o.o.**  
36-055 BRATKOWICE  
www.restol.com.pl

# Mistral MIP-2

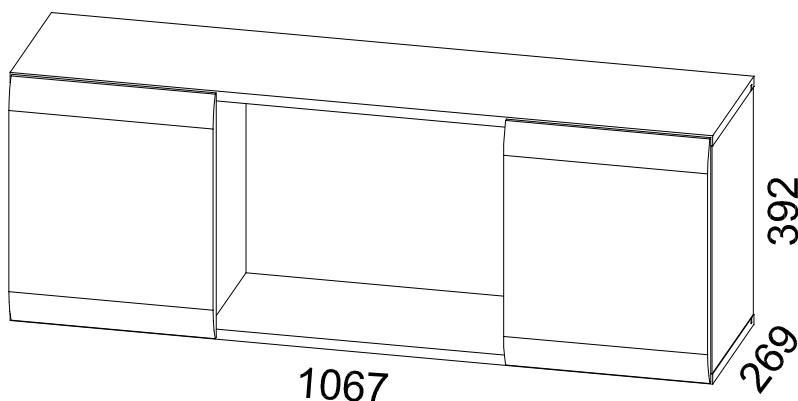

1067 x 392 x 269 /mm/

### **POKYN pro ošetřování nábytku!**

Díly čistit vlhkým hadříkem nebo papírovou utěrkou.

Nepoužívat chemické čisticí prostředky.

### **POKYNY k údržbě nábytku.**

Prvky nábytku čistit vlhkou handričkou nebo papírovou utěrkou.

Nepoužívat chemické čistiace prostředky.

### **WSKAZÓWKA na temat pielęgnacji mebla.**

Czyścić elementy wilgotną szmatką lub papierowym ręcznikiem.

Nie używać chemicznych środków czyszczących.

### **DIRECTION for the furniture cleaning.**

Clean elements with the moist wiper or soft paper towel. Do not use any detergents.

### **Pflegehinweis.**

Nur mit feuchtem Lappen, bzw. Papiertuch Ihre Möbel reinigen. Keine chemischen Waschmittel einsetzen.

**INSTRUKCJA MONTAŻU**  
 FITTING-UP INSTRUCTION / AUFBAUANLEITUNG  
 MONTÁŽNÍ NÁVOD / MONTÁŽNY NÁVOD

# Mistral MIP-2

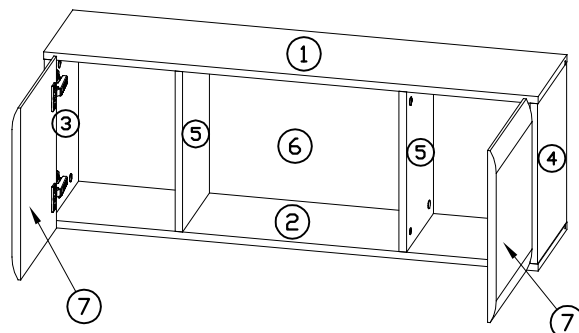
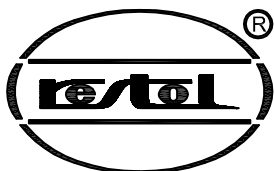

Do montażu potrzebne są:  
 You need for fitting-up:  
 Zur Montage werden Sie brauchen:  
 K montáži jsou potřebné:  
 Na montáž potrebujete:

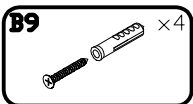
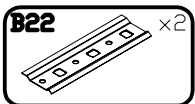
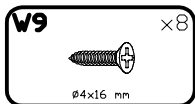
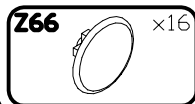
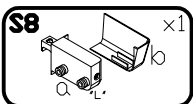
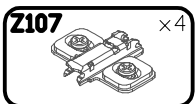
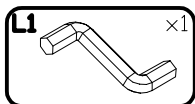
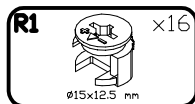
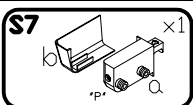
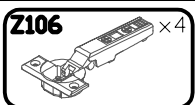
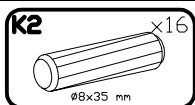
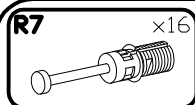
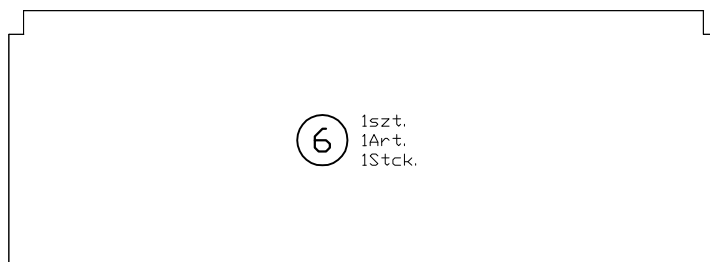
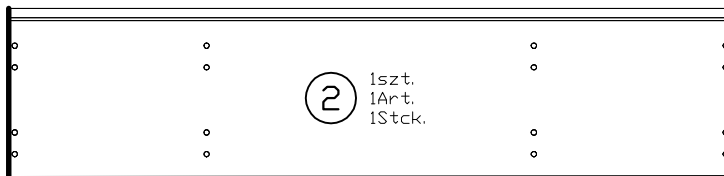
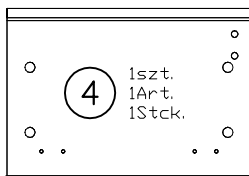
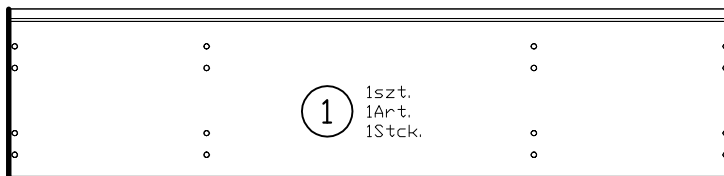
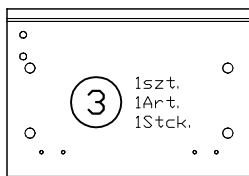
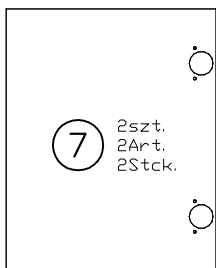
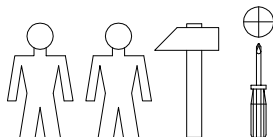

PODCZAS MONTAŻU POSTĘPOWAĆ ZGODNIE Z INSTRUKCJĄ  
 WHILE ASSEMBLING FOLLOW THE INSTRUCTION / MONTAGE LAUT DER AUFBAUANLEITUNG DURCHFÜHREN  
 PŘI MONTÁŽI POSTUPOVAT PODLE NÁVODU / PRI MONTÁŽI POSTUPOJTE PODĽA NÁVODU

# 1 Mistral MIP-2

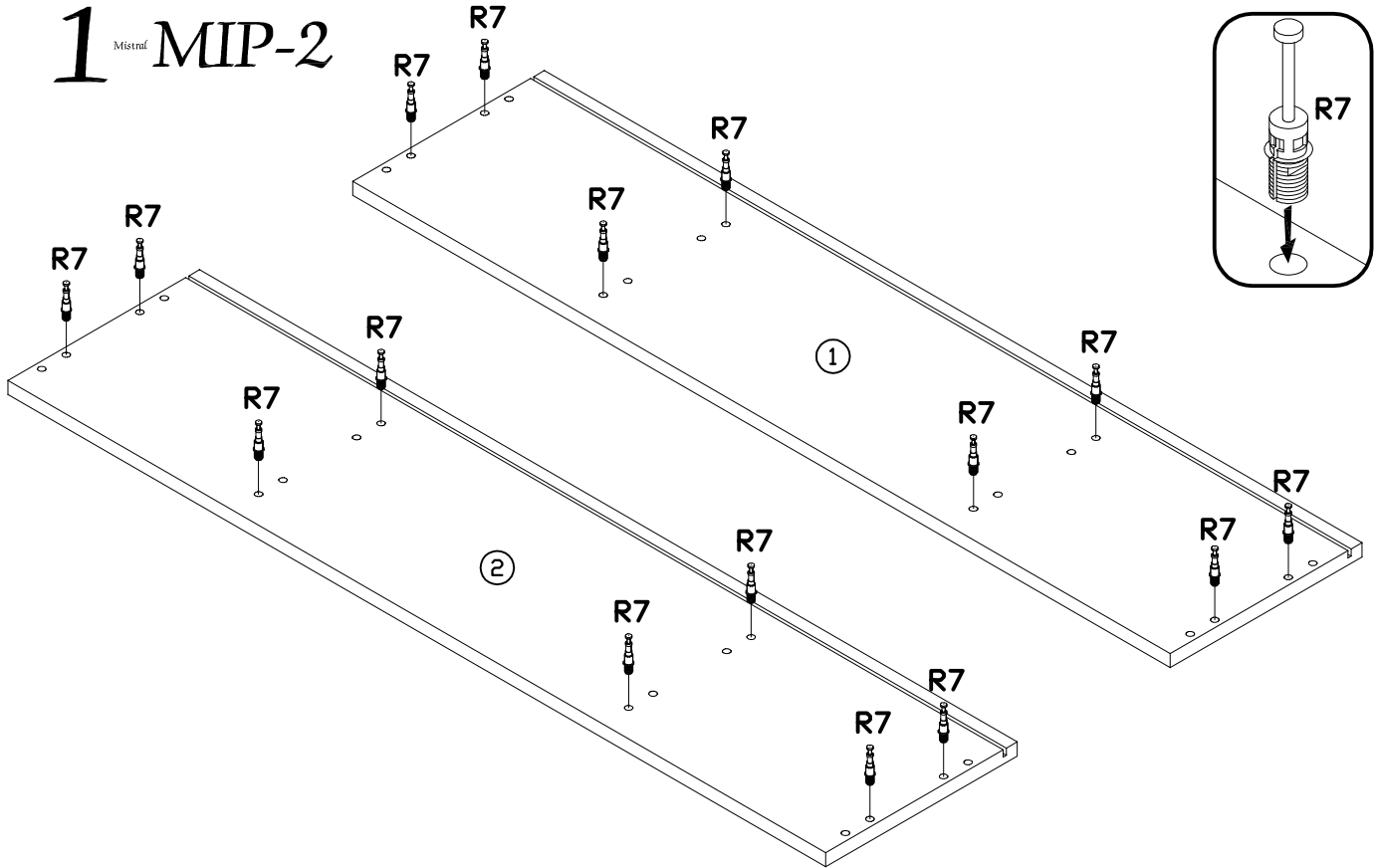

# 2 Mistral MIP-2

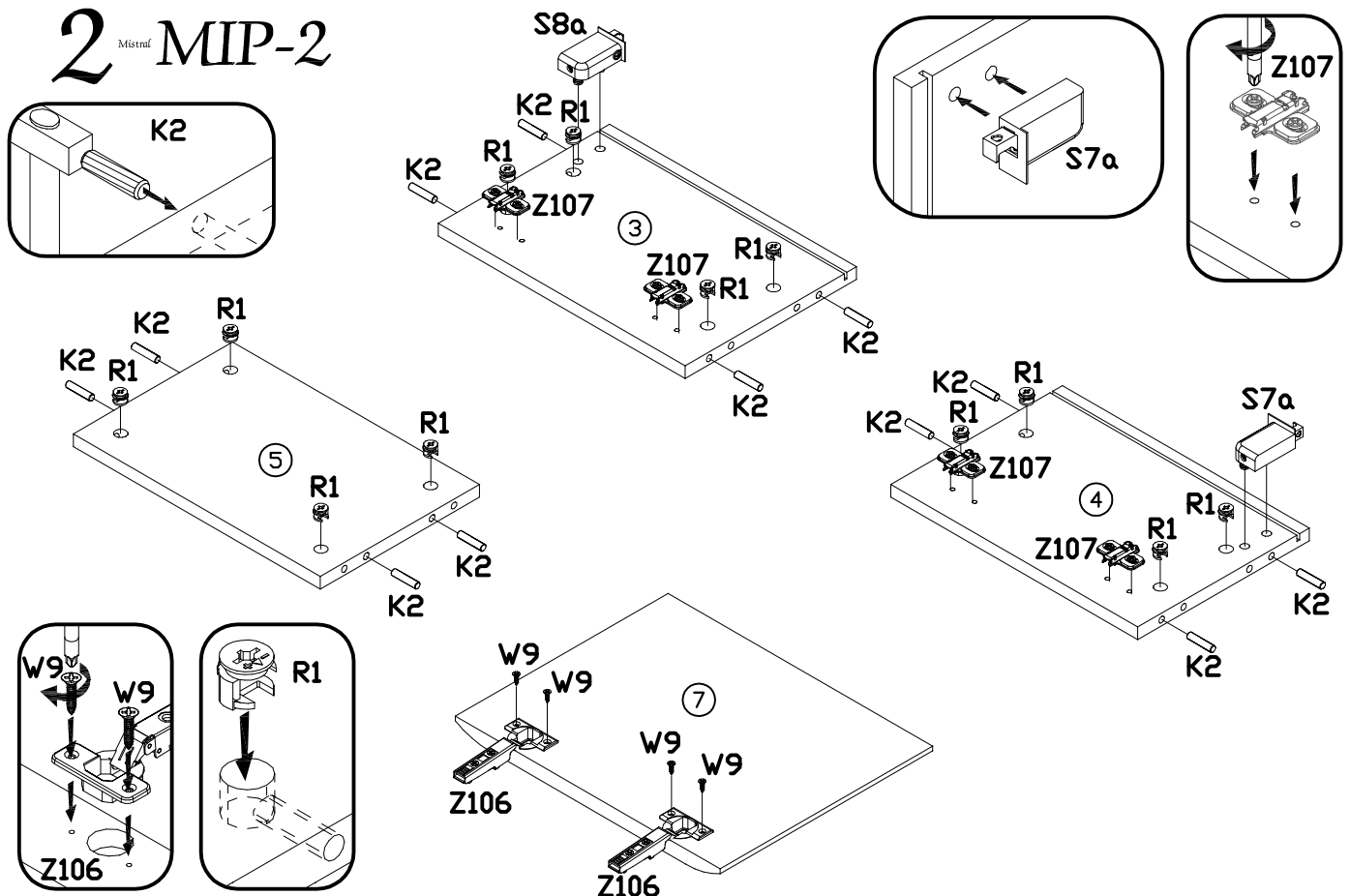

PODCZAS MONTAŻU POSTĘPOWAĆ ZGODNIE Z INSTRUKCJĄ  
WHILE ASSEMBLING FOLLOW THE INSTRUCTION / MONTAGE LAUT DER AUFBAUANLEITUNG DURCHFÜHREN  
PŘI MONTÁŽI POSTUPOVAT PODLE NÁVODU / PRI MONTÁŽI POSTUPOJTE PODĽA NÁVODU

### 3 Místně MIP-2

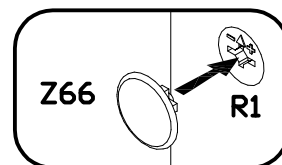
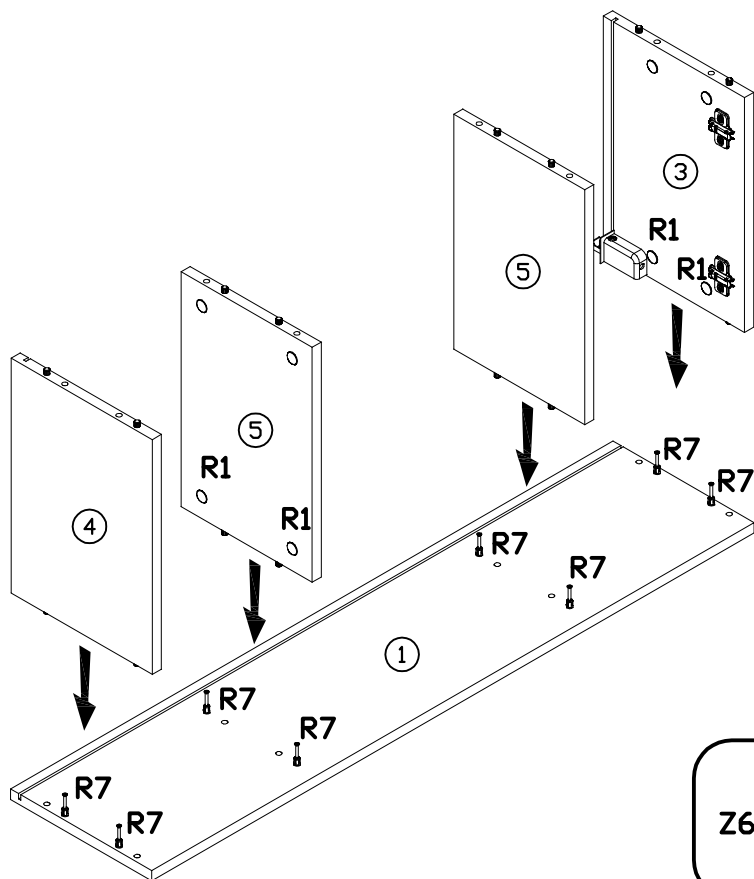
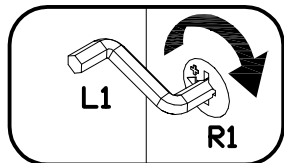
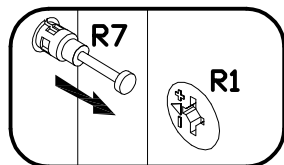

### 4 Místně MIP-2

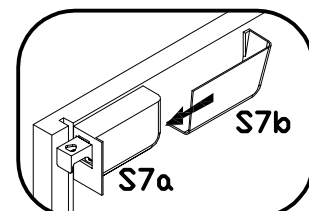
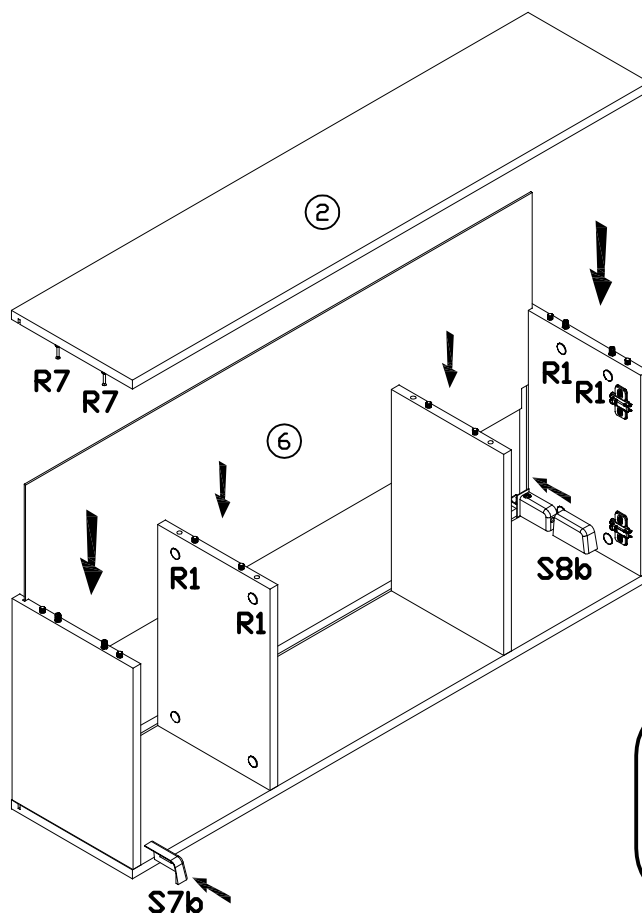
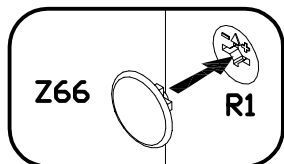
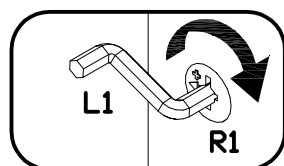
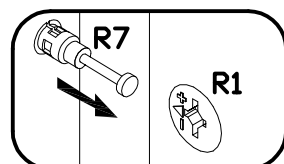

**PODCZAS MONTAŻU POSTĘPOWAĆ ZGODNIE Z INSTRUKCJĄ**  
WHILE ASSEMBLING FOLLOW THE INSTRUCTION / MONTAGE LAUT DER AUFBAUANLEITUNG DURCHFÜHREN  
PŘI MONTÁŽI POSTUPOVAT PODLE NÁVODU / PRI MONTÁŽI POSTUPUJTE PODĽA NÁVODU

# 5 Místní MIP-2

