

INSTRUKCJA MONTAŻU

FITTING-UP INSTRUCTION / AUFBAUANLEITUNG

MONTÁŽNÍ NÁVOD / MONTÁŽNY NÁVOD / SZERELÉSI UTASÍTÁS

Producent:
Restol sp. z o.o.
36-055 BRATKOWICE
www.restol.com.pl

Theo THN-1

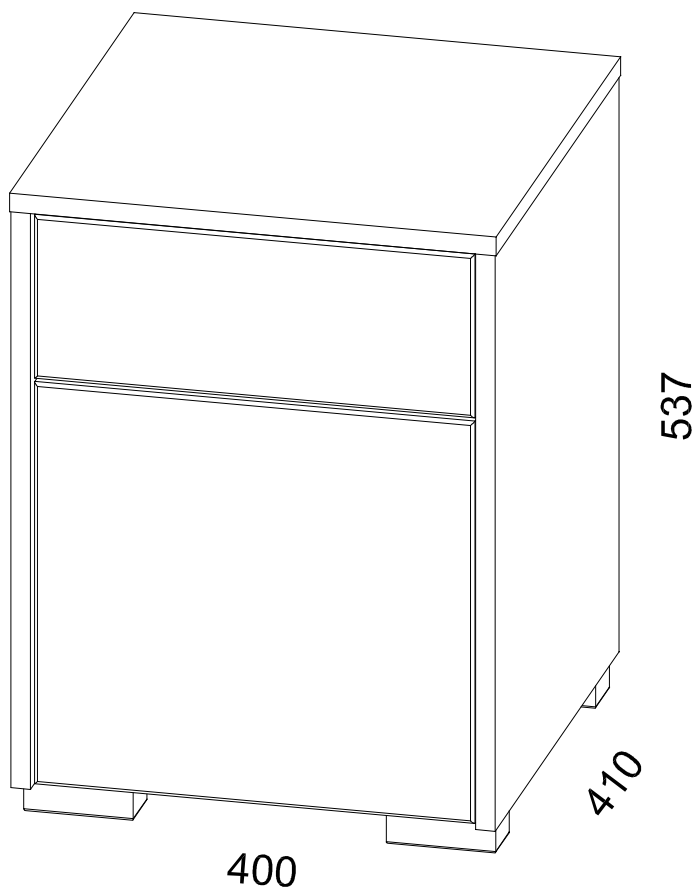
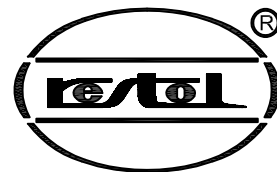

400 x 537 x 410 /mm/

WSKAZÓWKA na temat pielęgnacji mebla.

Czyścić elementy wilgotną szmatką lub papierowym ręcznikiem.
Nie używać chemicznych środków czyszczących.

DIRECTION for the furniture cleaning.

Clean elements with the moist wiper or soft paper towel. Do not use any detergents.

Pflegehinweis.

Nur mit feuchtem Lappen, bzw. Papiertuch Ihre Möbel reinigen.
Keine chemischen Waschmittel einsetzen.

POKYN pro ošetřování nábytku!

Díly čistit vlhkým hadříkem nebo papírovou utěrkou.
Nepoužívat chemické čističí prostředky.

POKYNY k údržbě nábytku.

Prvky nábytku čistit vlhkou handričkou alebo papierovou utierkou
Nepoužívať chemické čistiace prostriedky.

UTMATATÓ a bútor ápolására.

Az elemeket nedves ronggyal vagy papírtörülközővel tisztítani.
Vegyi tisztítószert nem használni.

Gwarancja dostępna pod linkiem:

Guarantee available at:

Die Garantie ist unter dem Link:

Záruka je k dispozici na

následujícím odkazu:

Záruka k dispozícii pod odkazom:

Link a jótálláshoz :

www.restol.com.pl/gwarancja.pdf

INSTRUKCJA MONTAŻU
 FITTING-UP INSTRUCTION / AUFBAUANLEITUNG
 MONTÁŽNÍ NÁVOD / MONTÁŽNY NÁVOD / SZERELÉSI UTASÍTÁS

Theo THN-1

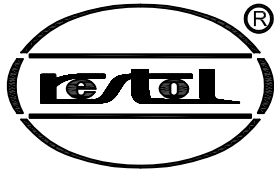

Do montażu potrzebne są:
 You need for fitting-up:
 Zur Montage werden Sie brauchen:
 K montáži jsou potřebné:
 Na montáž potrebujete:
 A szereléshez szükséges:

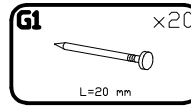
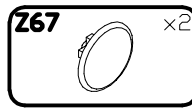
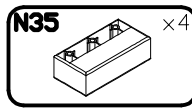
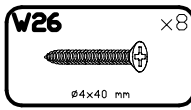
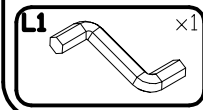
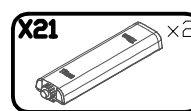
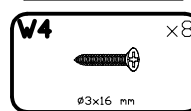
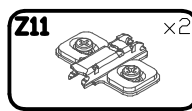
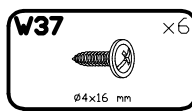
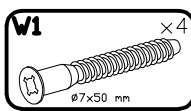
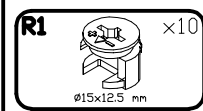
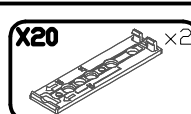
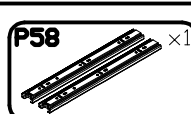
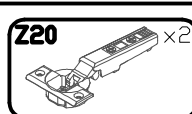
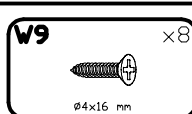
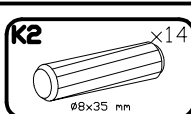
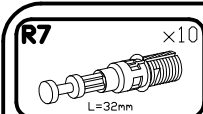
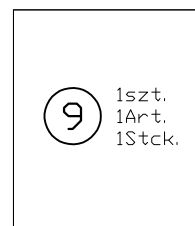
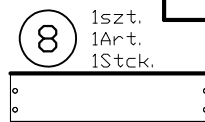
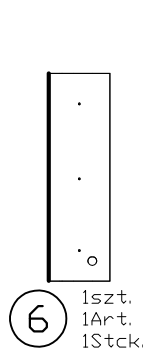
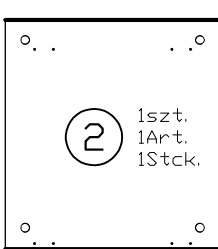
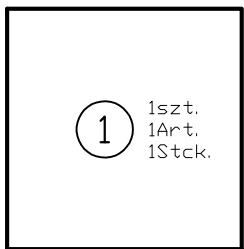
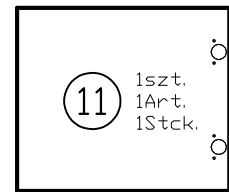
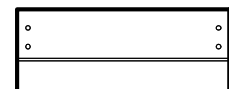
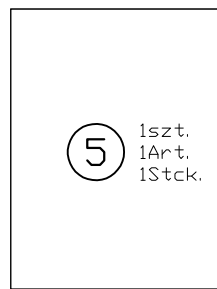
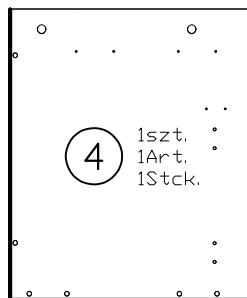
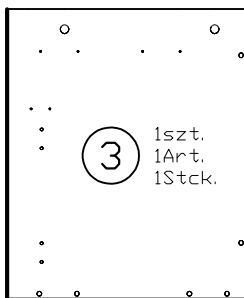
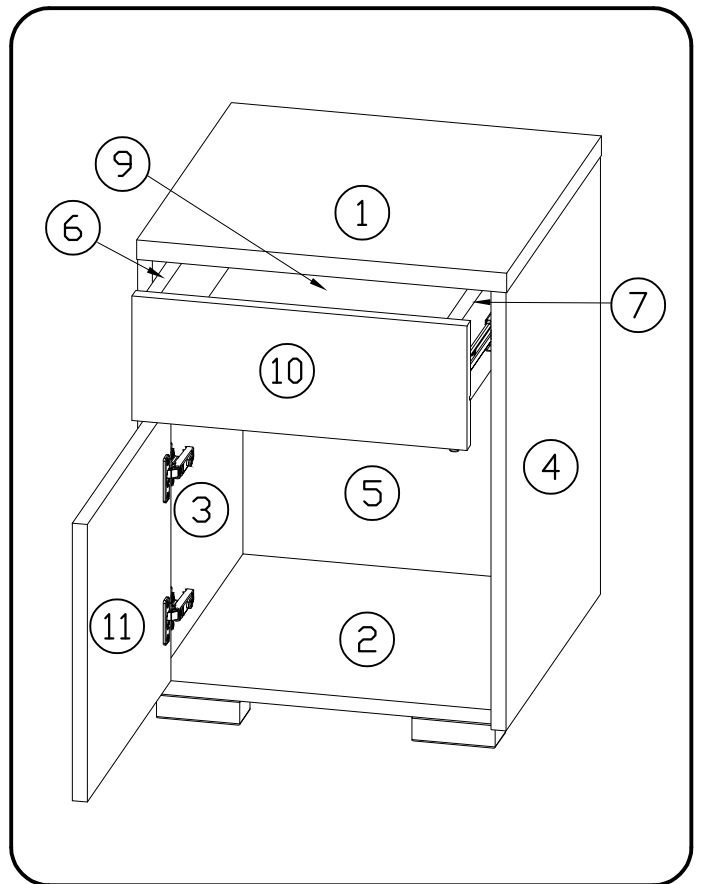
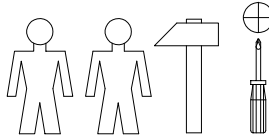

PODCZAS MONTAŻU POSTĘPOWAĆ ZGODNIE Z INSTRUKCJĄ

WHILE ASSEMBLING FOLLOW THE INSTRUCTION / MONTAGE LAUT DER AUFBAUANLEITUNG DURCHFÜHREN

PŘI MONTÁŽI POSTUPOVAT PODLE NÁVODU / PRI MONTÁŽI POSTUPUJTE PODĽA NÁVODU / SZERELÉSKOR UTASÍTÁS SZERINT ELJÁRNI

1 THco THN-1

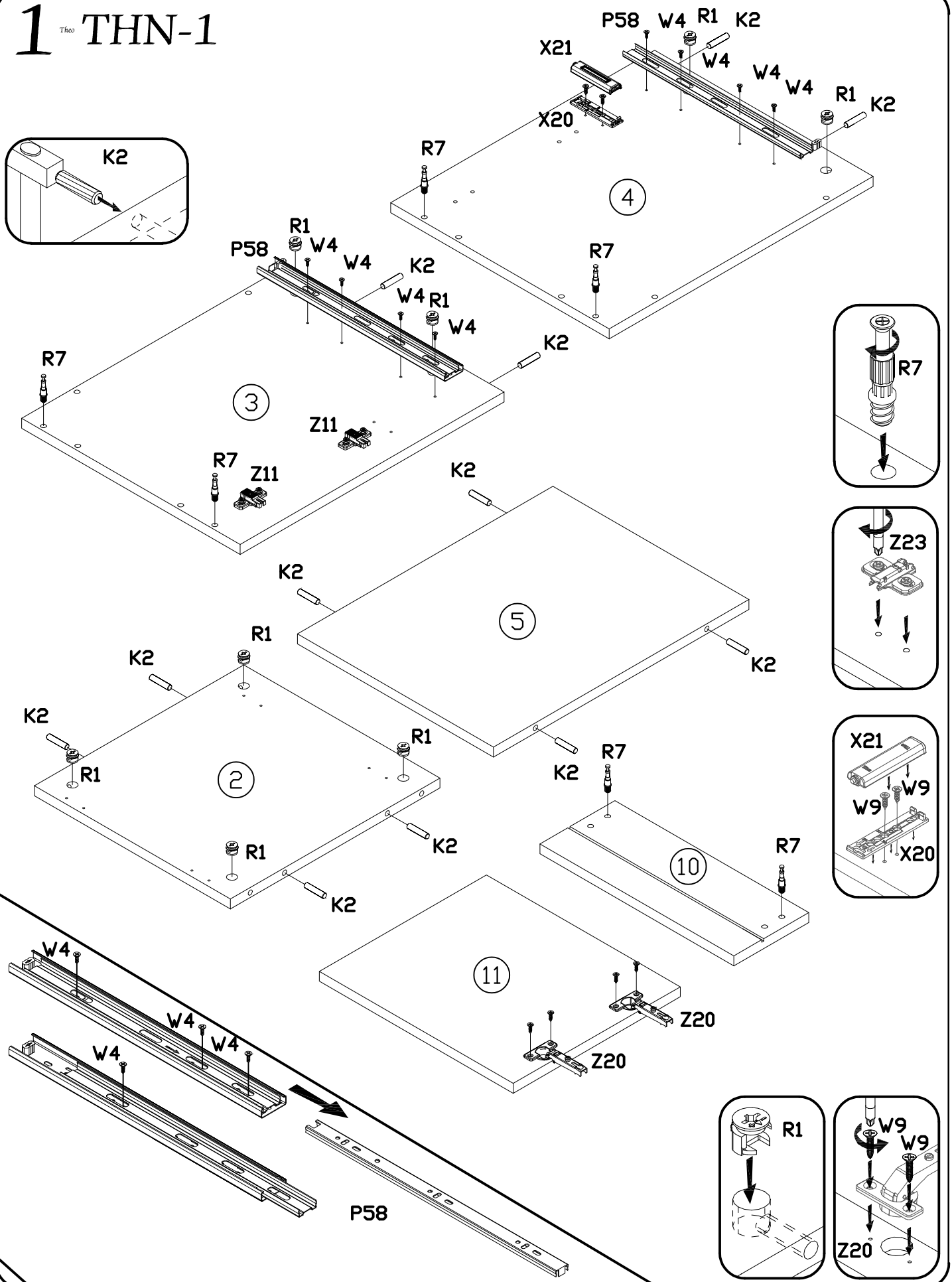

PODCZAS MONTAŻU POSTĘPOWAĆ ZGODNIE Z INSTRUKCJĄ

WHILE ASSEMBLING FOLLOW THE INSTRUCTION / MONTAGE LAUT DER AUFBAUANLEITUNG DURCHFÜHREN

PŘI MONTÁŽI POSTUPOVAT PODLE NÁVODU / PRI MONTÁŽI POSTUPOJTE PODĽA NÁVODU / SZERELÉSKOR UTASÍTÁS SZERINT ELJÁRNI

2 ^{Tfco} THN-1

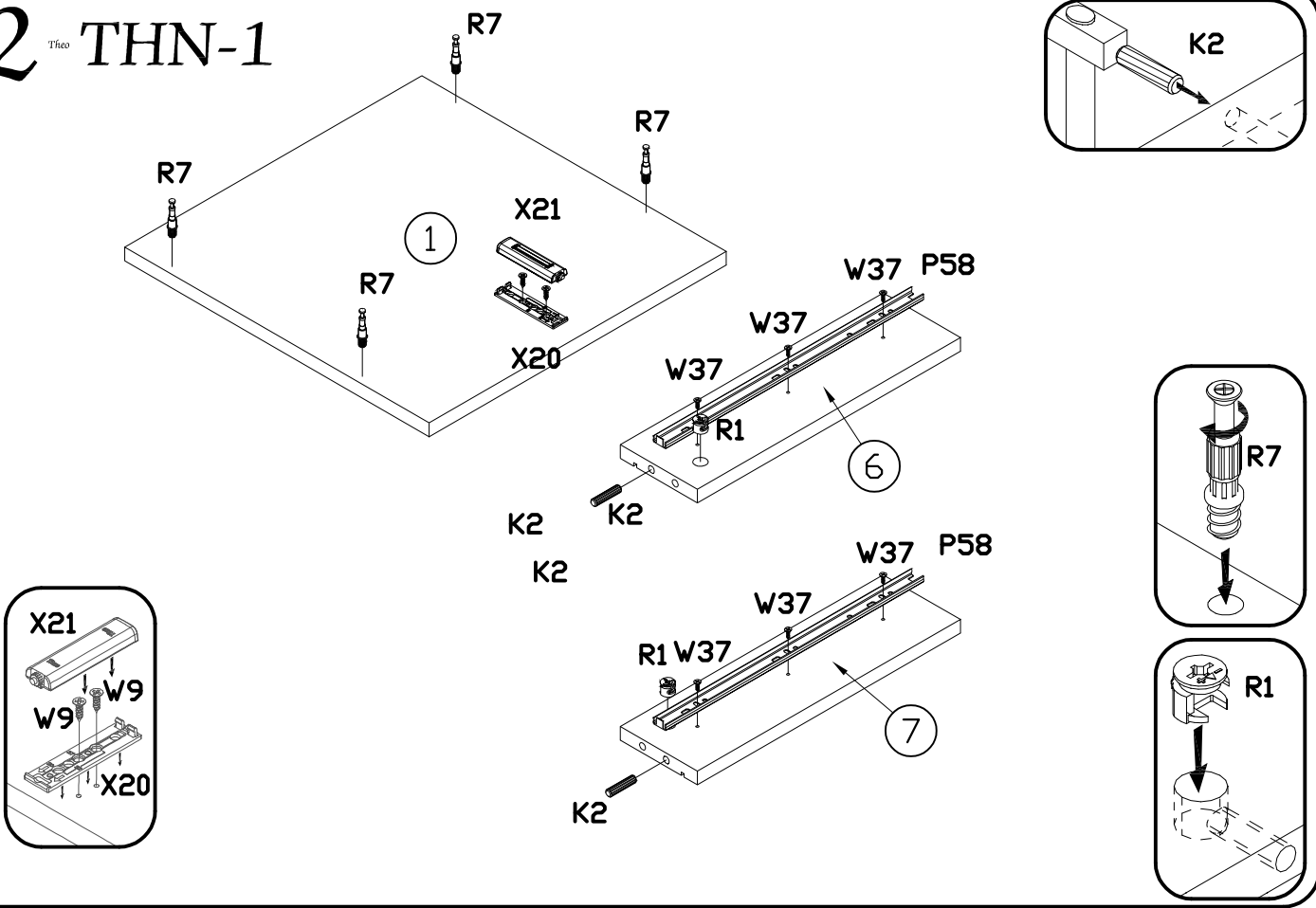

3 ^{Tfco} THN-1

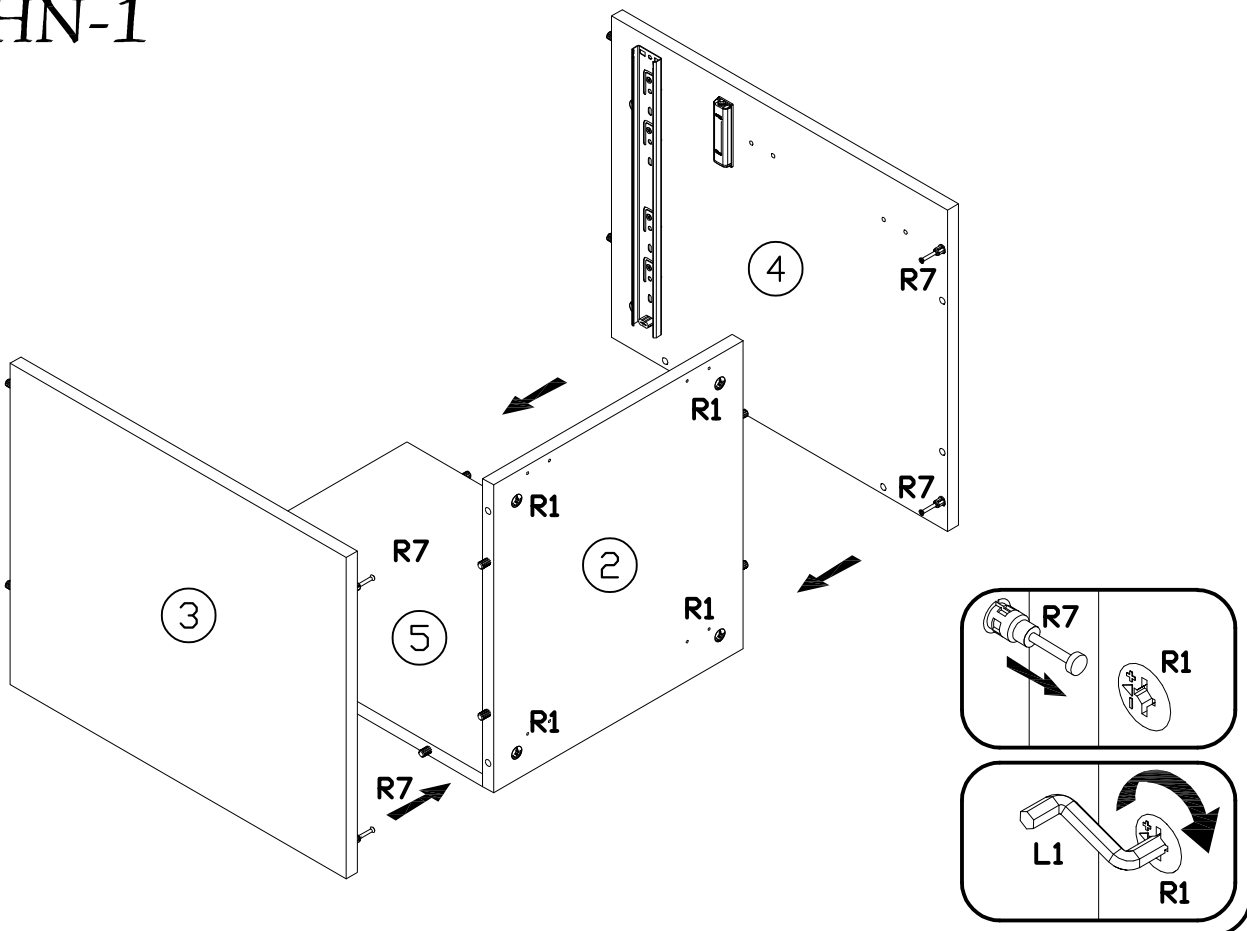

PODCZAS MONTAŻU POSTĘPOWAĆ ZGODNIE Z INSTRUKCJĄ

WHILE ASSEMBLING FOLLOW THE INSTRUCTION / MONTAGE LAUT DER AUFBAUANLEITUNG DURCHFÜHREN

PŘI MONTÁŽI POSTUPOVAT PODLE NÁVODU / PRI MONTÁŽI POSTUPUJTE PODĽA NÁVODU / SZERELÉSKOR UTASÍTÁS SZERINT ELJÁRNI

4 Tfco **THN-1**

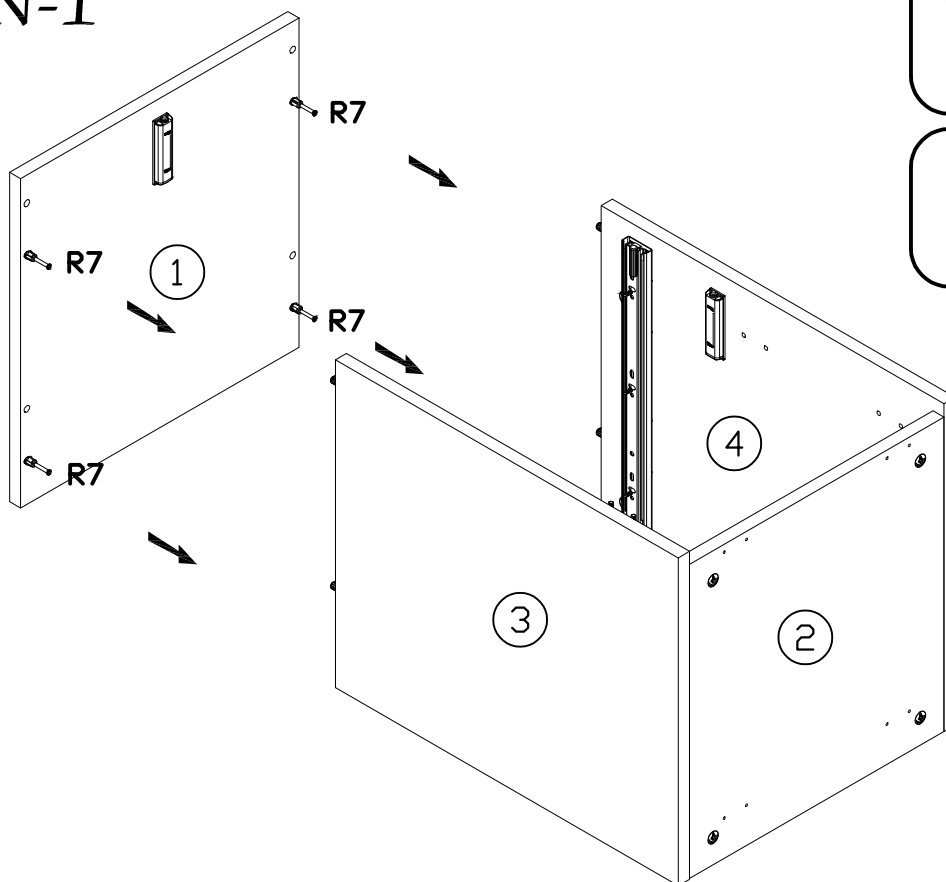

5 Tfco **THN-1**

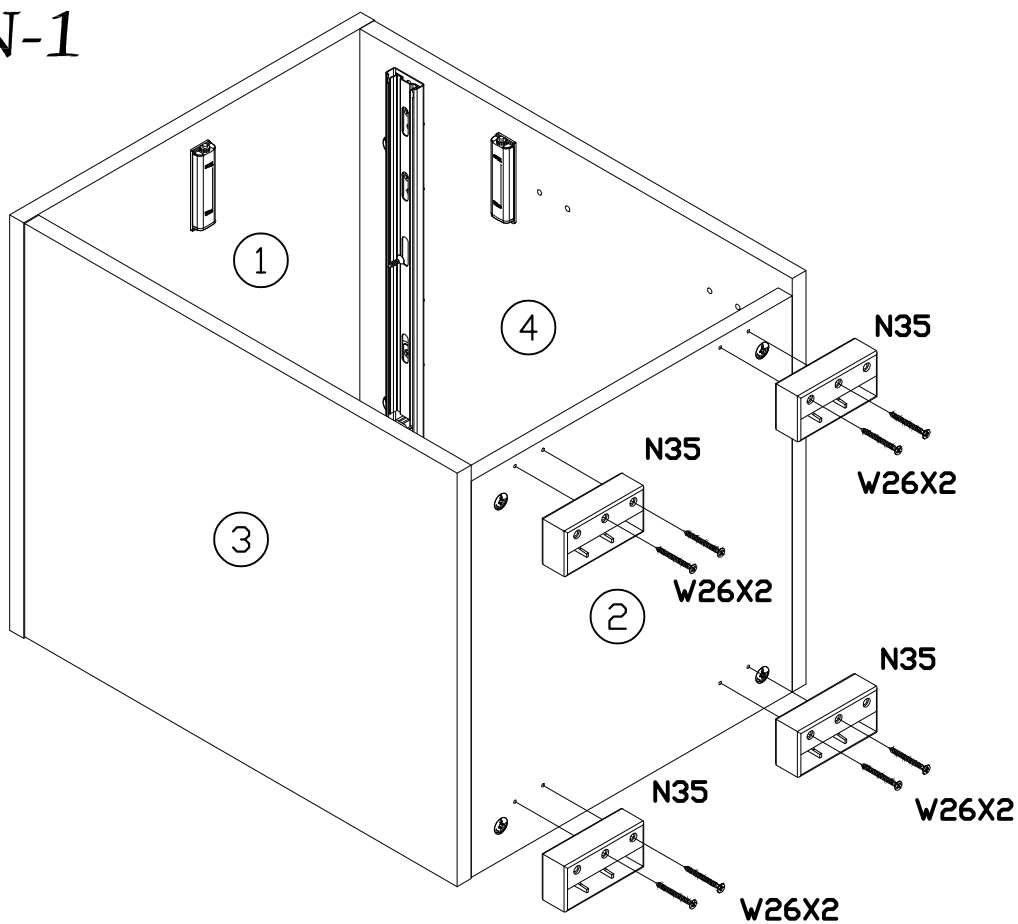

PODCZAS MONTAŻU POSTĘPOWAĆ ZGODNIE Z INSTRUKCJĄ

WHILE ASSEMBLING FOLLOW THE INSTRUCTION / MONTAGE LAUT DER AUFBAUANLEITUNG DURCHFÜHREN

PŘI MONTÁŽI POSTUPOVAT PODLE NÁVODU / PRI MONTÁŽI POSTUPUJTE PODĽA NÁVODU / SZERELÉSKOR UTASÍTÁS SZERINT ELJÁRNI

6 Tfco **THN-1**

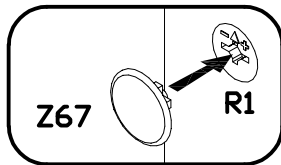
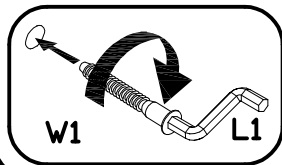
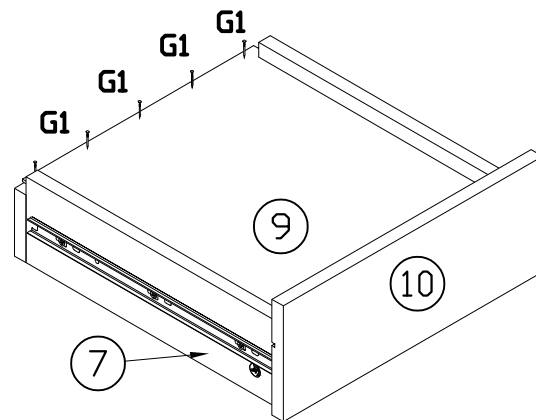
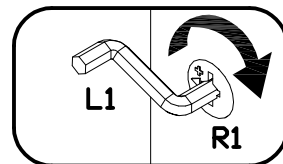
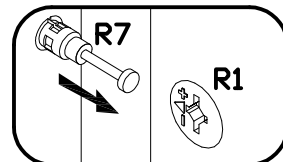
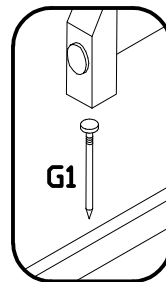
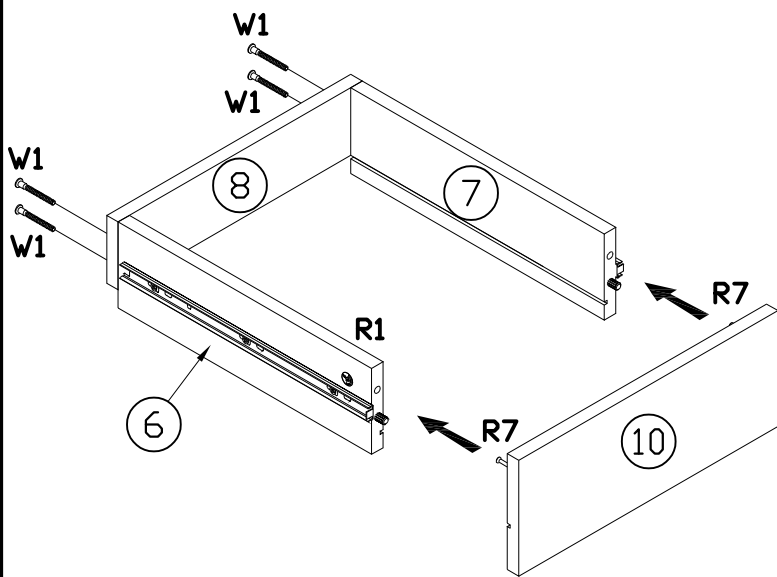

7 Tfco **THN-1**

